

Data sheet - BSO4-3,5-M3-6

Blind self-clinching standoffs for stainless steel and other sheet metals

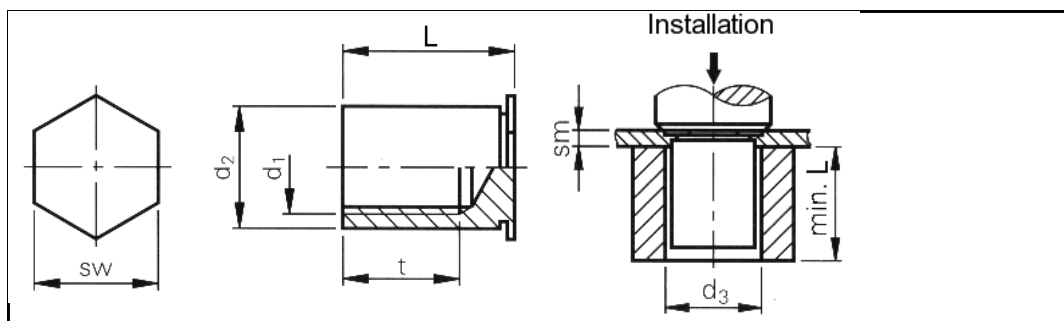

3D-Data available	
Order description	BSO4-3,5-M3-6
Thread d1	M3
Hole-Ø in the sheet +0.08 0	5.40 mm
d2 0 -0.13	5.39 mm
d3	5.6 mm
sw	6.4 mm
Min. sm	1.0 mm
L +0.05 -0.13	6 mm
Depth of thread tmin.	3.2 mm
Min. edge distance up to the hole centre	6.8 mm
Material	Passivated stainless steel (AISI 400).
Use	For sheet hardnesses up to HRB 88.
Tools	
Insertion machines	

uniform resource locator: